

176271-4 ✓ ACTIVE

AMP Universal Power

TE Internal #: 176271-4

Housing, Plug, Wire-to-Wire, 2 Position, 3.96 mm [.156 in]
Centerline, Wire & Cable, UL 94V-0, AMP Universal Power,
Rectangular Power Connectors

[View on TE.com >](#)



Connectors > Power Connectors > Rectangular Power > Rectangular Power Connectors

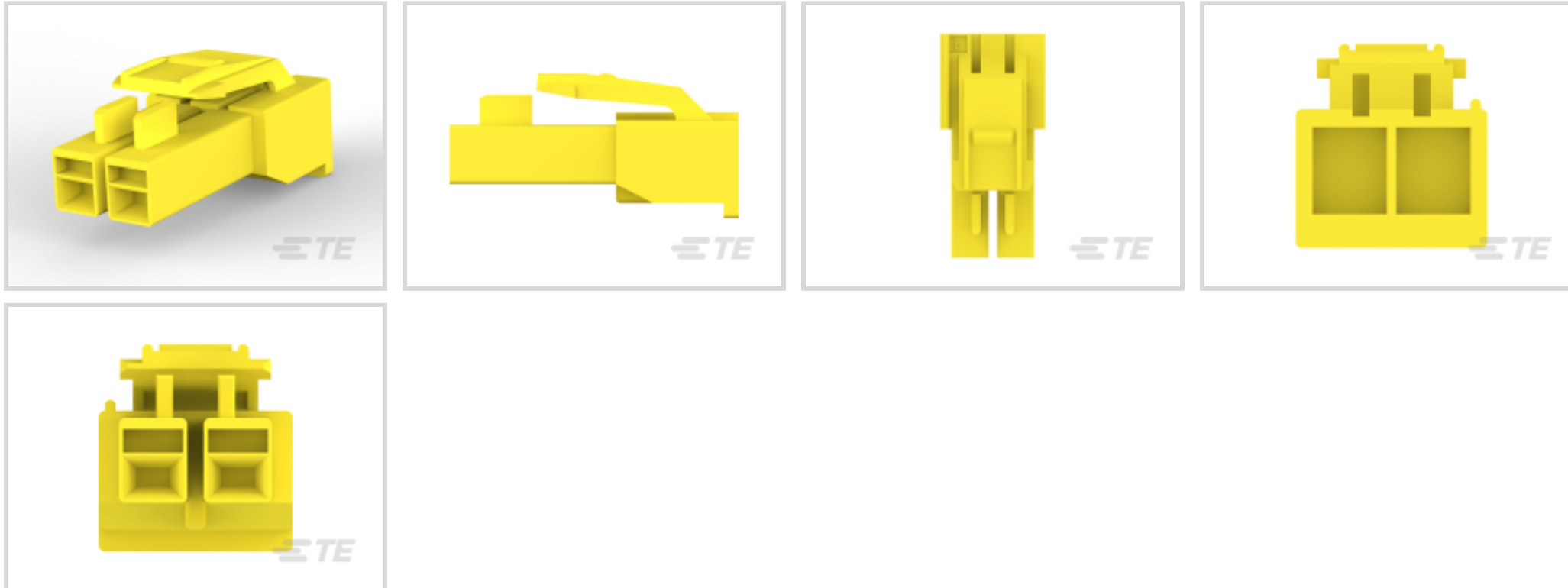

EU RoHS Compliance: **Compliant**

EU ELV Compliance: **Compliant**

Rectangular Power Connector Type: **Housing**

Connector & Housing Type: **Plug**

Connector System: **Wire-to-Wire**

Features

Other

EU RoHS Compliance	Compliant
EU ELV Compliance	Compliant

Product Type Features

Rectangular Power Connector Type	Housing
Connector & Housing Type	Plug
Connector System	Wire-to-Wire
Sealable	No
Connector & Contact Terminates To	Wire & Cable

Configuration Features

Number of Positions	2
Number of Power Positions	0
Number of Signal Positions	0
Number of Rows	1

Electrical Characteristics



Operating Voltage	300 VAC
-------------------	---------

Contact Features

Contact Layout	Inline
Contact Retention Within Housing	Without
Contact Type	Receptacle

Termination Features

Termination Method to Wire & Cable	Crimp
------------------------------------	-------

Mechanical Attachment

Strain Relief	Without
Panel Mount Feature	Without
Mating Retention Type	Latch
PCB Mount Retention	Without
Mating Retention	With
Mating Alignment Type	Polarization
Mating Alignment	Without
Connector Mounting Type	Cable Mount (Free-Hanging)

Housing Features

Centerline (Pitch)	3.96 mm [.156 in]
Housing Color	Yellow
Housing Material	PA 6/6

Dimensions

Product Length	9.06 mm
Connector Height	10.05 mm

Usage Conditions

Operating Temperature Range	-30 – 105 °C [-22 – 221 °F]
-----------------------------	-----------------------------

Operation/Application

Circuit Application	Power & Signal
---------------------	----------------

Industry Standards

UL Flammability Rating	UL 94V-0
Glow Wire Rating	Standard Part - Not Glow Wire

Packaging Features



Packaging Quantity	1000
Packaging Method	Bag

Product Compliance

[For compliance documentation, visit the product page on TE.com>](#)

EU RoHS Directive 2011/65/EU	Compliant
EU ELV Directive 2000/53/EC	Compliant
China RoHS 2 Directive MIIT Order No 32, 2016	No Restricted Materials Above Threshold
EU REACH Regulation (EC) No. 1907/2006	Current ECHA Candidate List: JUNE 2024 (241) Candidate List Declared Against: JUNE 2024 (241) Does not contain REACH SVHC
Halogen Content	Low Halogen - Br, Cl, F, I < 900 ppm per homogenous material. Also BFR/CFR/PVC Free
Solder Process Capability	Not applicable for solder process capability

Product Compliance Disclaimer

This information is provided based on reasonable inquiry of our suppliers and represents our current actual knowledge based on the information they provided. This information is subject to change. The part numbers that TE has identified as EU RoHS compliant have a maximum concentration of 0.1% by weight in homogenous materials for lead, hexavalent chromium, mercury, PBB, PBDE, DBP, BBP, DEHP, DIBP, and 0.01% for cadmium, or qualify for an exemption to these limits as defined in the Annexes of Directive 2011/65/EU (RoHS2). Finished electrical and electronic equipment products will be CE marked as required by Directive 2011/65/EU. Components may not be CE marked. Additionally, the part numbers that TE has identified as EU ELV compliant have a maximum concentration of 0.1% by weight in homogenous materials for lead, hexavalent chromium, and mercury, and 0.01% for cadmium, or qualify for an exemption to these limits as defined in the Annexes of Directive 2000/53/EC (ELV). Regarding the REACH Regulation, the information TE provides on SVHC in articles for this part number is based on the latest European Chemicals Agency (ECHA) 'Guidance on requirements for substances in articles' posted at this URL: <https://echa.europa.eu/guidance-documents/guidance-on-reach>

Compatible Parts



TE Part # 175156-2
U/P REC CONT L/P



TE Part # 175155-1
UNIV POWER REC CONT L/P



TE Part # 178495-1
UP 3.96 2P DIP HDR NAT

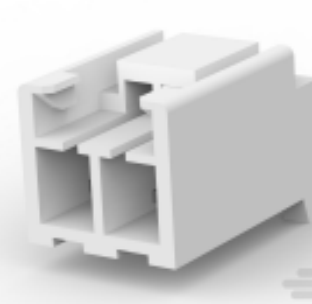

TE Part # 9-176975-1
AMP UNIVERSAL POWER PLG 2P PCB

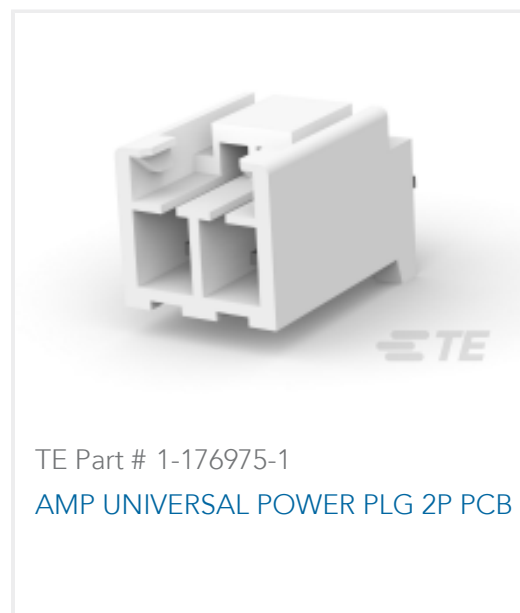
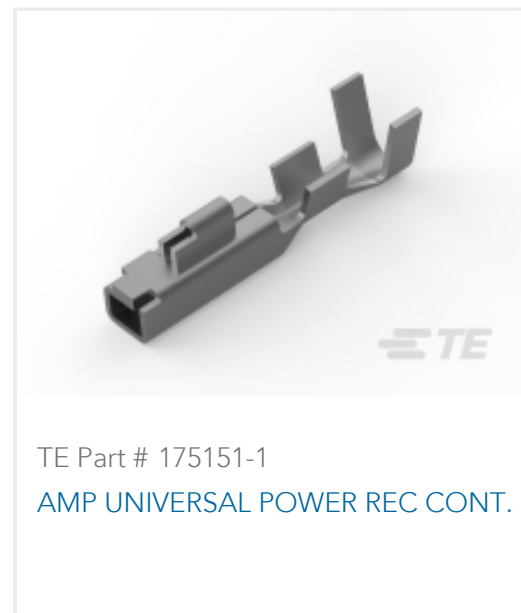

Also in the Series | **AMP Universal Power**

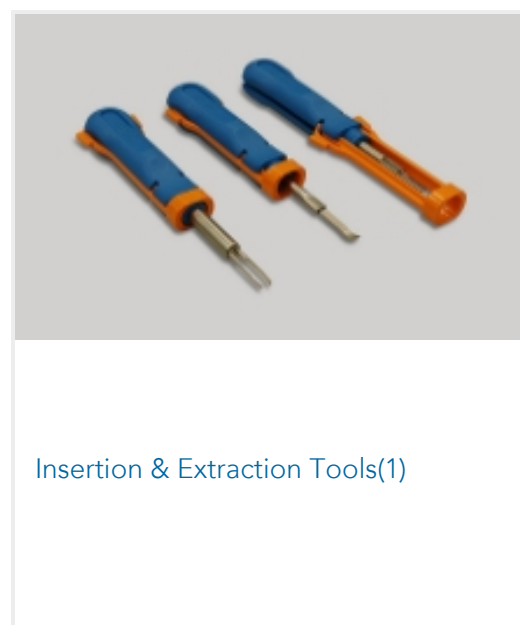
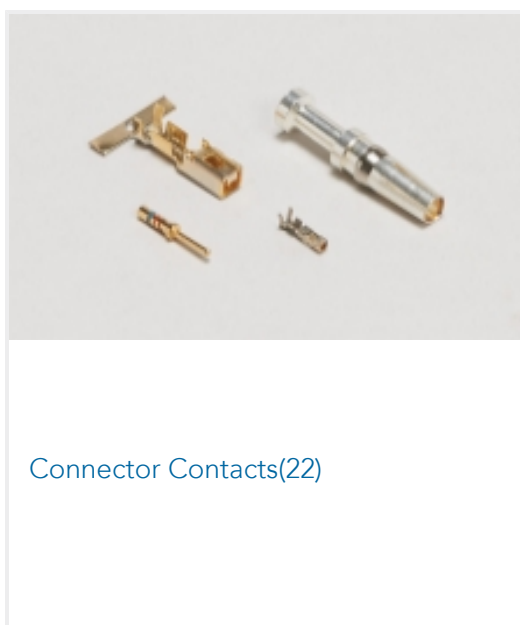

Customers Also Bought

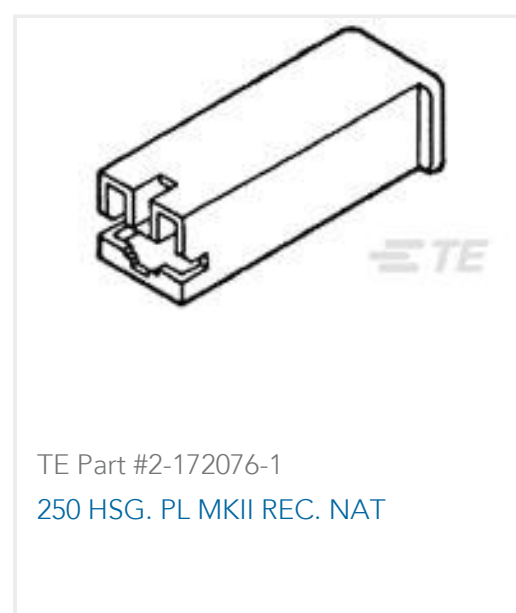

Documents

Product Drawings

AMP UNIVERSAL POWER PLUG 2P

English

CAD Files

Customer View Model

[ENG_CVM_CVM_176271-4_H.2d_dxf.zip](#)

English

3D PDF

3D

Customer View Model

[ENG_CVM_CVM_176271-4_H.3d_igs.zip](#)

English

Customer View Model

[ENG_CVM_CVM_176271-4_H.3d_stp.zip](#)

English

By downloading the CAD file I accept and agree to the [Terms and Conditions](#) of use.

Product Specifications

Crimping of Universal Power Contact

English

Product Specification

Japanese

AMP Universal Power Connector

Japanese

Instruction Sheets

AMP UNIVERSAL POWER CONNECTOR SERIES

English

Instruction Sheet (non U.S.)

English

Agency Approvals

UL Report

English

176271-4

Housing, Plug, Wire-to-Wire, 2 Position, 3.96 mm [.156 in] Centerline, Wire & Cable,
UL 94V-0, AMP Universal Power, Rectangular Power Connectors

