



MTA 156

TE Internal #: 640383-8

PCB Mount Header, Vertical, Wire-to-Board, 8 Position, 3.96 mm [.156 in] Centerline, Unshrouded, Tin, Through Hole - Solder, Power, Natural, MTA 156

[View on TE.com >](#)

Connectors > PCB Connectors > PCB Headers & Receptacles



EU RoHS Compliance: **Compliant**

EU ELV Compliance: **Compliant**

PCB Connector Assembly Type: **PCB Mount Header**

PCB Mount Orientation: **Vertical**

Connector System: **Wire-to-Board**

Features

Other

EU RoHS Compliance	Compliant
EU ELV Compliance	Compliant

Product Type Features

Mixed & Hybrid Header	No
Connector Shape	Rectangular
PCB Connector Assembly Type	PCB Mount Header
Connector System	Wire-to-Board
Header Type	Unshrouded
Sealable	No
Connector & Contact Terminates To	Printed Circuit Board

Configuration Features

Number of Columns	8
Number of Loaded Positions	8
Number of Power Positions	8



Connector Contact Load Condition	Fully Loaded
PCB Mount Orientation	Vertical
Number of Positions	8
Number of Rows	1

Electrical Characteristics

Operating Voltage	600 VAC
-------------------	---------

Body Features

Primary Product Color	Natural
-----------------------	---------

Contact Features

Contact Underplating Material	Nickel
Contact Underplating Material Thickness	1.27 μ m[50 μ in]
Contact Size	1.14mm
Contact Mating Area Plating Material Thickness	2.54 μ m[100 μ in]
Mating Square Post Dimension	1.14 mm[.045 in]
PCB Contact Termination Area Plating Material Thickness	2.54 μ m[100 μ in]
Contact Shape & Form	Square
Contact Layout	Inline
Contact Mating Area Length	10.16 mm[.4 in]
Contact Base Material	Copper Alloy
PCB Contact Termination Area Plating Material	Tin
Contact Mating Area Plating Material	Tin
Contact Type	Tab
Contact Current Rating (Max)	14.24 A

Termination Features

Termination Post & Tail Length	3.18 mm[.125 in]
Square Termination Post & Tail Dimension	1.14 mm[.045 in]
Termination Method to PCB	Through Hole - Solder

Mechanical Attachment

Panel Mount Feature	Without
Mating Retention	Without
PCB Mount Retention	Without
PCB Mount Alignment	Without



Connector Mounting Type	Board Mount
-------------------------	-------------

Mating Alignment	Without
------------------	---------

Housing Features

Mating Entry Location	Top
-----------------------	-----

Housing Material	Thermoplastic Polyester - Glass-Filled
------------------	--

Centerline (Pitch)	3.96 mm [.156 in]
--------------------	-------------------

Dimensions

Connector Width	6.35 mm [.25 in]
-----------------	------------------

PCB Thickness (Recommended)	1.57 mm [.062 in]
-----------------------------	-------------------

Connector Height	13.34 mm [.525 in]
------------------	--------------------

Connector Length	31.7 mm [1.248 in]
------------------	--------------------

Usage Conditions

Operating Temperature (Max)	105 °C [221 °F]
-----------------------------	-----------------

Operating Temperature Range	-55 – 105 °C [-67 – 221 °F]
-----------------------------	-----------------------------

Operation/Application

Circuit Application	Power
---------------------	-------

Industry Standards

Compatible With Agency/Standards Products	UL, CSA
---	---------

UL Rating	Recognized
-----------	------------

Compatible With Approved Standards Products	UL E28476
---	-----------

Glow Wire Rating	Standard Part - Not Glow Wire
------------------	-------------------------------

UL Flammability Rating	UL 94V-0
------------------------	----------

Packaging Features

Packaging Quantity	750
--------------------	-----

Packaging Method	Package
------------------	---------

Product Compliance

[For compliance documentation, visit the product page on TE.com>](#)

EU RoHS Directive 2011/65/EU	Compliant
------------------------------	-----------

EU ELV Directive 2000/53/EC	Compliant
-----------------------------	-----------

China RoHS 2 Directive MIIT Order No 32, 2016	No Restricted Materials Above Threshold
---	---

EU REACH Regulation (EC) No. 1907/2006	
--	--



Current ECHA Candidate List: JUNE 2024 (241)

Candidate List Declared Against: JUNE 2024 (241)

Does not contain REACH SVHC

Halogen Content

Not Low Halogen - contains Br or Cl > 900 ppm.

Solder Process Capability

Wave solder capable to 265°C

Product Compliance Disclaimer

This information is provided based on reasonable inquiry of our suppliers and represents our current actual knowledge based on the information they provided. This information is subject to change. The part numbers that TE has identified as EU RoHS compliant have a maximum concentration of 0.1% by weight in homogenous materials for lead, hexavalent chromium, mercury, PBB, PBDE, DBP, BBP, DEHP, DIBP, and 0.01% for cadmium, or qualify for an exemption to these limits as defined in the Annexes of Directive 2011/65/EU (RoHS2). Finished electrical and electronic equipment products will be CE marked as required by Directive 2011/65/EU. Components may not be CE marked. Additionally, the part numbers that TE has identified as EU ELV compliant have a maximum concentration of 0.1% by weight in homogenous materials for lead, hexavalent chromium, and mercury, and 0.01% for cadmium, or qualify for an exemption to these limits as defined in the Annexes of Directive 2000/53/EC (ELV). Regarding the REACH Regulation, the information TE provides on SVHC in articles for this part number is based on the latest European Chemicals Agency (ECHA) 'Guidance on requirements for substances in articles' posted at this URL: <https://echa.europa.eu/guidance-documents/guidance-on-reach>

Compatible Parts



TE Part # CAT-103156-WBHSM
Receptacle Housing: Wire-to-Board, with Mating Alignment, SL156



TE Part # 640251-8
08P SL156 HSG W/O LCK RAMP



TE Part # 3-640428-8
08P MTA156 CONN ASSY 22AWG RED



TE Part # 3-643817-8
08P MTA156 CONN ASSY 18AWG ORA



TE Part # 643067-8
08P MTA156 MOLDED COVER



TE Part # 3-640606-8
08P MTA156 CONN ASSY 22AWG LF



TE Part # 3-640427-8
08P MTA156 CONN ASSY 20AWG YEL



TE Part # 3-640602-8
08P MTA156 CONN ASSY 24AWG LF



Also in the Series | **MTA 156**

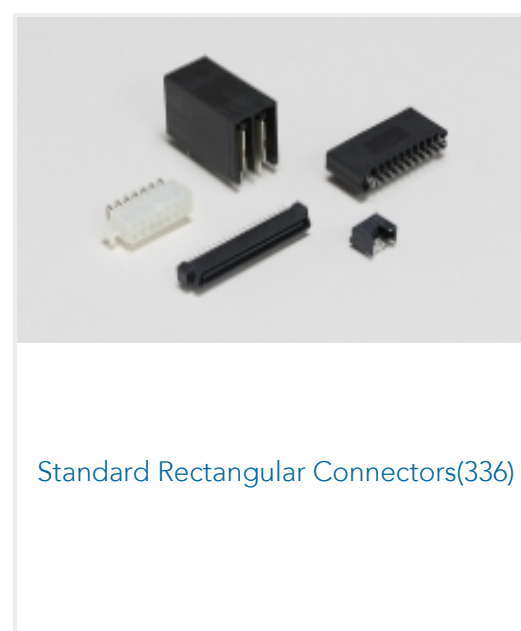
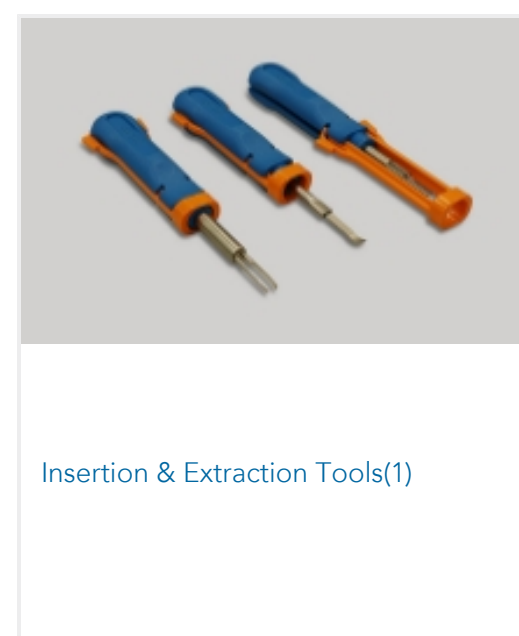
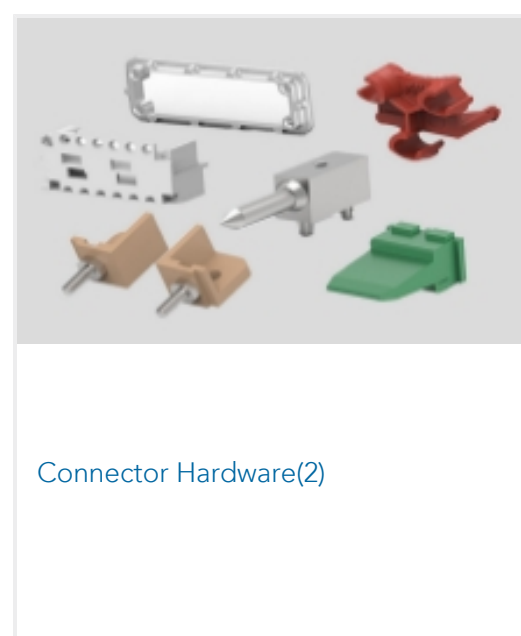
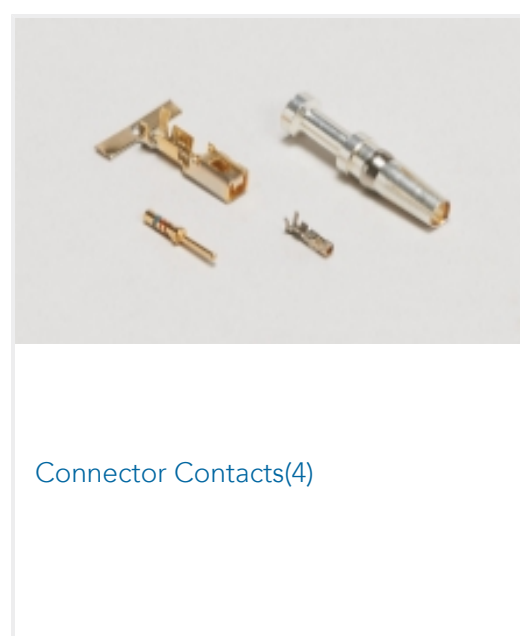

Customers Also Bought

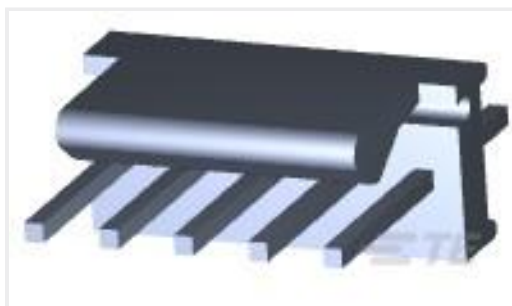

TE Part #640456-5
05P MTA100 HDR ASSY F/L SQ STR



TE Part #3-5177986-5
0.8FH,P08H.5,120,08/Sn,TR,SC

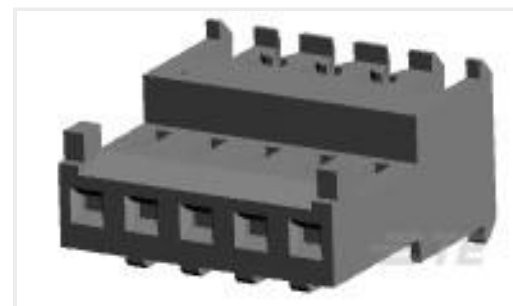

TE Part #3-644563-5
05P MTA100 CONN ASSY F/T 24AWG



TE Part #5188578-1
Z-PACK/A M HDR.154P



TE Part #5-520315-2
TRIOMATE ASSY V 2P L=3.556LDFR

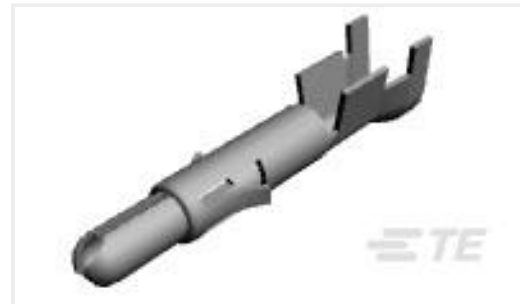

TE Part #350687-7
UMNL SPLIT PIN AUNI/BR



TE Part #640383-3
03P MTA156 HDR ASSY STR SQ SN



TE Part #1-160301-9
250 FASTON,REC.,10-12 AWG,PHBZ



TE Part #640383-9
09P MTA156 HDR ASSY STR SQ SN

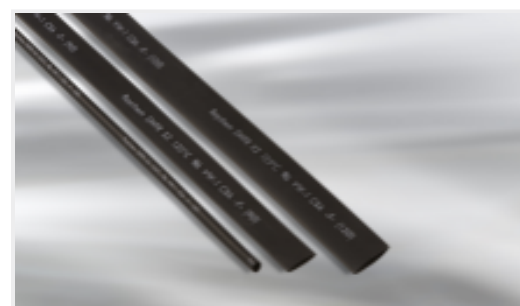

TE Part #EM7487-000
X2-6.0-0-SP-SM

Documents

Product Drawings

[08P MTA156 HDR ASSY STR SQ SN](#)

English

CAD Files

Customer View Model

[ENG_CVM_CVM_640383-8_AD.2d_dxf.zip](#)

English

3D PDF

3D

Customer View Model

[ENG_CVM_CVM_640383-8_AD.3d_igs.zip](#)

English

Customer View Model

[ENG_CVM_CVM_640383-8_AD.3d_stp.zip](#)

English

By downloading the CAD file I accept and agree to the [Terms and Conditions](#) of use.

Product Specifications



Application Specification

English

Agency Approvals

Agency Approval Document

English