

42192-1 ✓ ACTIVE

AMPLIVAR

TE Internal #: 42192-1

Thru Splice, 22 – 15 AWG Wire Size, .3 – 1.5 mm² Wire Size, Splice Capacity 3, Serrated, 600 – 3000 CMA Wire Size, Brass, AMPLIVAR, Splices

[View on TE.com >](#)



Terminals & Splices > Splices

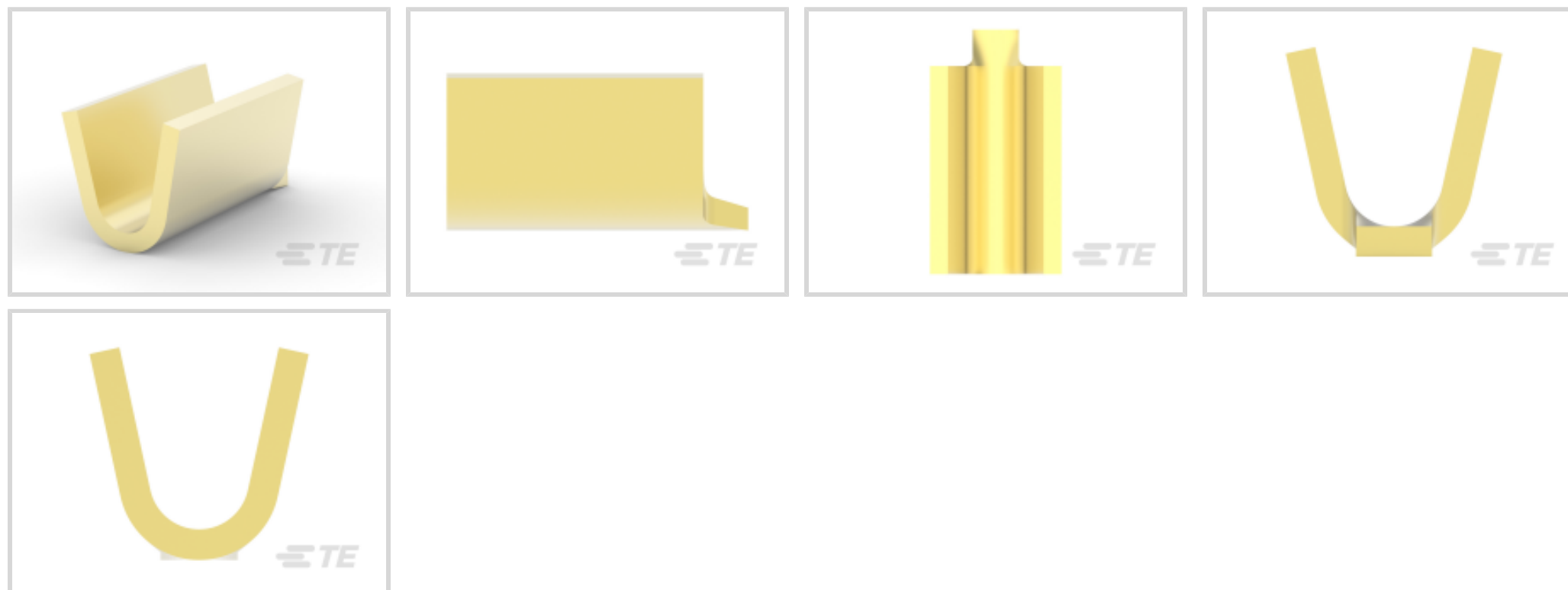

Splice Type: Thru Splice

Wire Size: .3 – 1.5 mm²

Sealable: No

Splice Capacity: 3

Features

Electrical Characteristics

Operating Voltage	250 V
-------------------	-------

Termination Features

Crimp Width	2.79 mm[.11 in]
-------------	-----------------

Packaging Features

Packaging Quantity	30000
--------------------	-------

Packaging Method	Strip
------------------	-------

Contact Features

Terminal Thickness	40 μin
--------------------	--------

Terminal Plating Material	Unplated
---------------------------	----------

Contact Base Material	Brass
-----------------------	-------

Barrel Type	Open
-------------	------

Body Features

Product Weight	.221 g
----------------	--------

Splice Features	Serrated
-----------------	----------



Configuration Features

Strip Orientation	End Feed
Splice Capacity	3
Number of Serrations	5

Product Type Features

Splice Type	Thru Splice
Sealable	No
Compatible With Discrete Wire Type	Solid, Magnet Wire

Mechanical Attachment

Wire Insulation Support	Without
-------------------------	---------

Dimensions

Wire Size	600 – 3000 CMA
Terminal Material Thickness	.51 mm[.02 in]
Product Length	5.72 mm[.225 in]

Usage Conditions

Insulation Option	Uninsulated
Operating Temperature Range	-65 – 150 °C[-85 – 302 °F]

Operation/Application

Compatible With Wire Base Material	Copper
------------------------------------	--------

Industry Standards

Government Qualified Splice	No
-----------------------------	----

Other

EU RoHS Compliance	Compliant
EU ELV Compliance	Compliant

Product Compliance

[For compliance documentation, visit the product page on TE.com>](#)

EU RoHS Directive 2011/65/EU	Compliant
EU ELV Directive 2000/53/EC	Compliant
China RoHS 2 Directive MIIT Order No 32, 2016	No Restricted Materials Above Threshold
EU REACH Regulation (EC) No. 1907/2006	Current ECHA Candidate List: JUNE 2024 (241)



Candidate List Declared Against: JUNE 2024 (241)
Does not contain REACH SVHC

Halogen Content

Low Halogen - Br, Cl, F, I < 900 ppm per homogenous material. Also BFR/CFR/PVC Free

Solder Process Capability

Not applicable for solder process capability

Product Compliance Disclaimer

This information is provided based on reasonable inquiry of our suppliers and represents our current actual knowledge based on the information they provided. This information is subject to change. The part numbers that TE has identified as EU RoHS compliant have a maximum concentration of 0.1% by weight in homogenous materials for lead, hexavalent chromium, mercury, PBB, PBDE, DBP, BBP, DEHP, DIBP, and 0.01% for cadmium, or qualify for an exemption to these limits as defined in the Annexes of Directive 2011/65/EU (RoHS2). Finished electrical and electronic equipment products will be CE marked as required by Directive 2011/65/EU. Components may not be CE marked. Additionally, the part numbers that TE has identified as EU ELV compliant have a maximum concentration of 0.1% by weight in homogenous materials for lead, hexavalent chromium, and mercury, and 0.01% for cadmium, or qualify for an exemption to these limits as defined in the Annexes of Directive 2000/53/EC (ELV). Regarding the REACH Regulation, the information TE provides on SVHC in articles for this part number is based on the latest European Chemicals Agency (ECHA) 'Guidance on requirements for substances in articles' posted at this URL: <https://echa.europa.eu/guidance-documents/guidance-on-reach>

Compatible Parts



TE Part # 63564-1
SPLICE AMVAR 2000-5400 020BR



TE Part # 42778-2
SPLICE AMPLIVAR 600-3000 CMA



TE Part # 41765
SPLC AMVAR 1500-5000 020BR



TE Part # 62157-1
SPLICE AMVAR 600-3000 .020BR



TE Part # 62000-1
SPLICE AMVAR 600-3000 020BR



TE Part # 42776-1
SPLC AMVAR 1500-5000 020BR



TE Part # 1217384-1
AMVAR SPL 600-3000 7 SERR TPBR

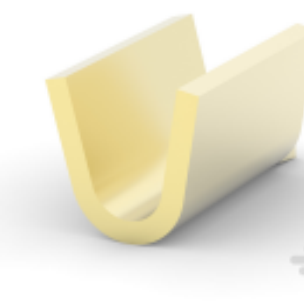

TE Part # 170152-3
AMP SPLICE



Also in the Series | **AMPLIVAR**

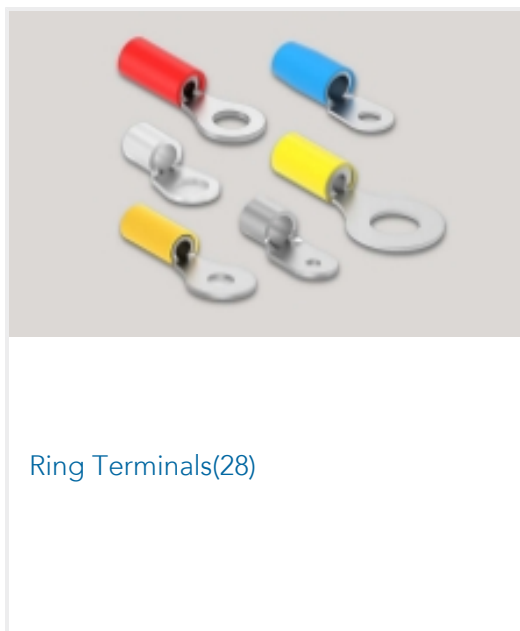
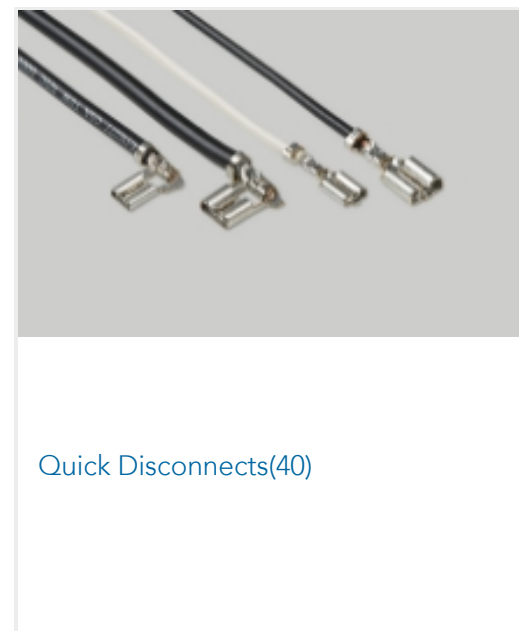
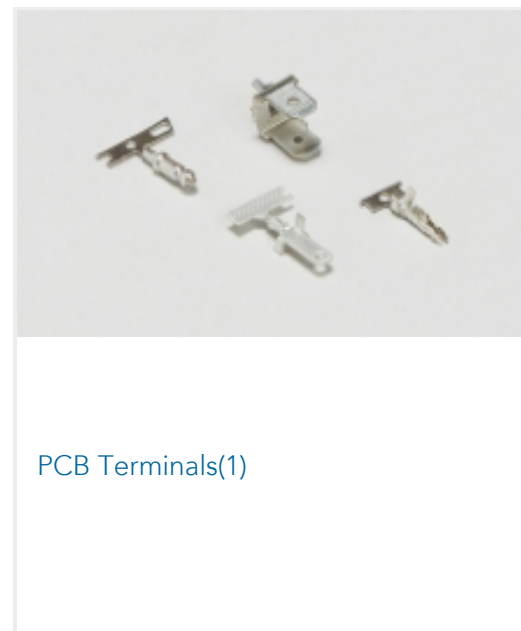

Customers Also Bought

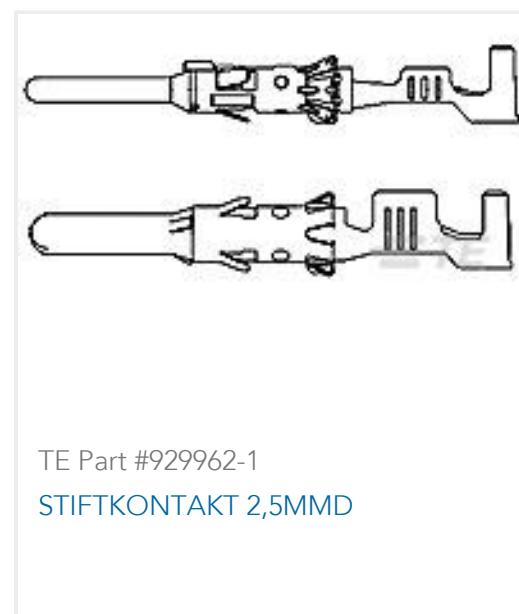
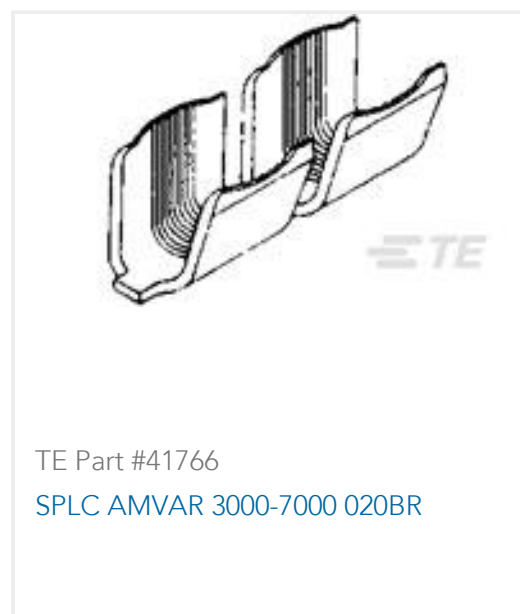



TE Part #170943-000
2019E0309-0

Documents

Product Drawings

[SPLC AMVAR 600-3000 020BR](#)

English

CAD Files

[3D PDF](#)

3D

Customer View Model

[ENG_CVM_CVM_42192-1_W_c-42192-1-w.2d_dxf.zip](#)

English

Customer View Model

[ENG_CVM_CVM_42192-1_W_c-42192-1-w.3d_igs.zip](#)

English

Customer View Model

[ENG_CVM_CVM_42192-1_W_c-42192-1-w.3d_stp.zip](#)

English

By downloading the CAD file I accept and agree to the [Terms and Conditions](#) of use.

Datasheets & Catalog Pages

[1654742_HOUSEHOLD_APPLIANCES_RAST5](#)

English

[Magnet Wire Terminals & Splices](#)

English

Product Specifications

[Application Specification](#)

English

[AMPLIVAR 5 Serration Thru Splice](#)

English