

LOC	DIST
FT	0

REVISIONS

P	LTR	DESCRIPTION	DATE	DWN	APVD
	C4	PN 2-282959-0 RELEASED FOR PRODUCTION	04DEC2018	RK	PS
	C5	PART OBSOLETE	30JUL2021	GMN	PS

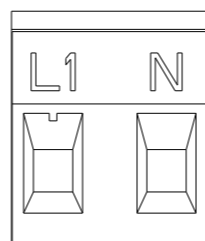
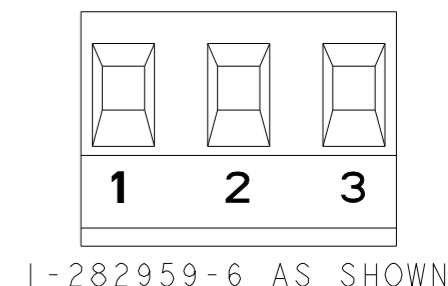
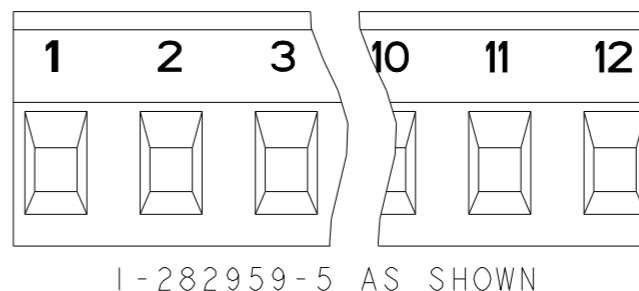
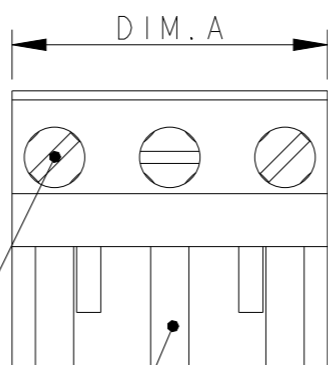
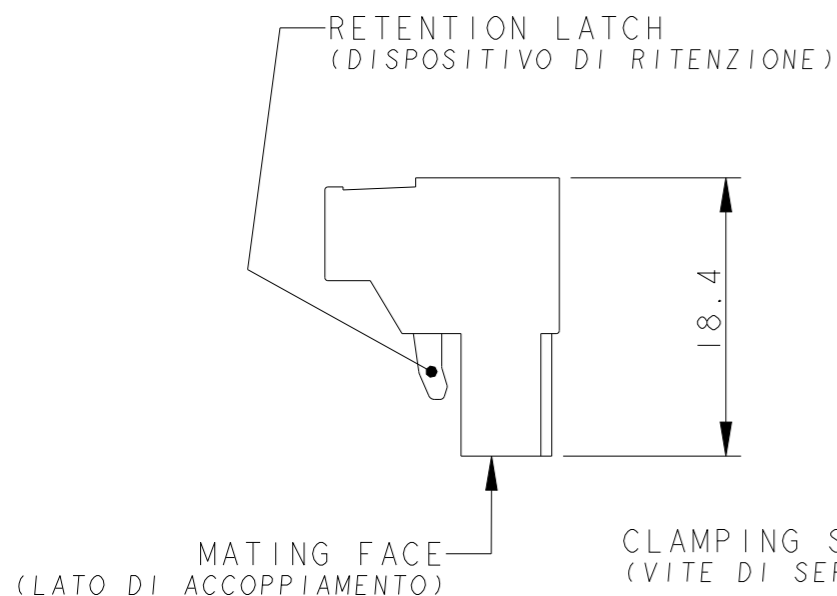

2-282959-0 AS SHOWN

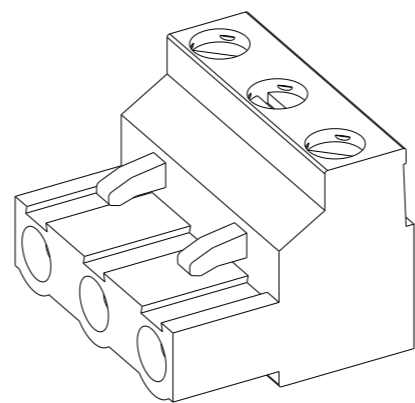

282959-3 AS SHOWN

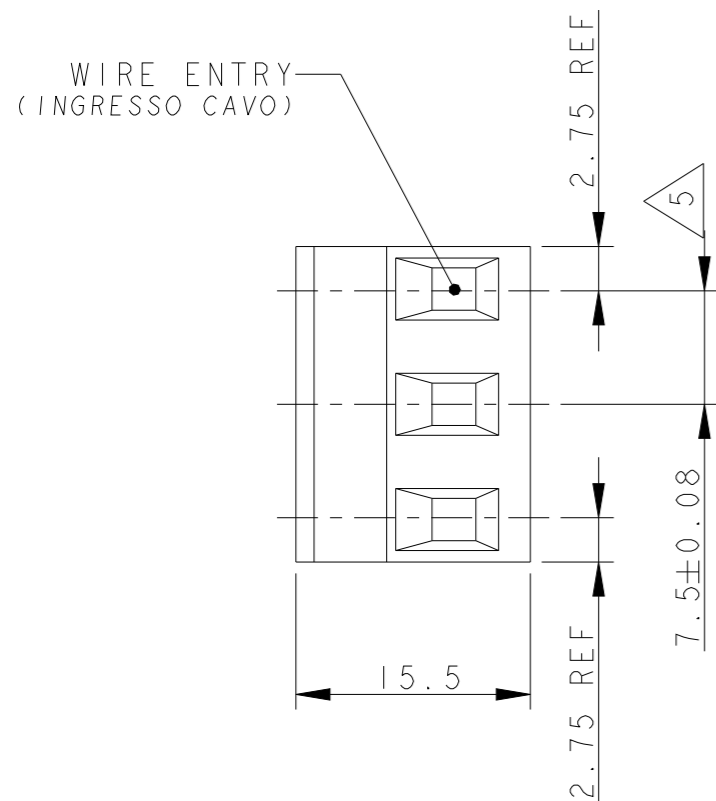

OBSOLETE

AS SHOWN	COLOUR	DIM. A	NO OF POS.	PART NUMBER
AS SHOWN	GREEN	13.0	2	2-282959-0
/	GRAY	20.5	3	1-282959-9
AS SHOWN	GREEN	20.5	3	1-282959-6
AS SHOWN	GREEN	90.0	12	1-282959-5
/	GREEN	73.0	10	1-282959-4
/	BLACK	20.5	3	1-282959-3
/	GREEN	88.0	12	1-282959-2
/	GREEN	80.5	11	1-282959-1
/	GREEN	73.0	10	1-282959-0
/	GREEN	65.5	9	282959-9
/	GREEN	58.0	8	282959-8
/	GREEN	50.5	7	282959-7
/	GREEN	43.0	6	282959-6
/	GREEN	35.5	5	282959-5
/	GREEN	28.0	4	282959-4
/	GREEN	20.5	3	282959-3
/	GREEN	13.0	2	282959-2

THIS DRAWING IS A CONTROLLED DOCUMENT.	
DIMENSIONS: mm	TOLERANCES UNLESS OTHERWISE SPECIFIED:
	0 PLC ± 1 PLC ±0.2 2 PLC ±0.20 3 PLC ±0.001 4 PLC ±0.0001 ANGLES ±2
MATERIAL	FINISH

DWN	S. SCHLEGEL	25JUN96
CHK	R CANTORE	25JUN96
APVD	R CANTORE	25JUN96
PRODUCT SPEC	-	
APPLICATION SPEC	-	
WEIGHT	-	
CUSTOMER DRAWING		

STE TE Connectivity

NAME: TERMINAL BLOCK PLUG, 7.5mm PITCH

SIZE	CAGE CODE	DRAWING NO	RESTRICTED TO
A300779	C=282959		-

SCALE: 2:1 SHEET 1 OF 2 REV C5

THIS DRAWING IS UNPUBLISHED.

RELEASED FOR PUBLICATION

20

© COPYRIGHT 20

ALL RIGHTS RESERVED.

LOC FT DIST 0

REVISIONS

P	LTR	DESCRIPTION	DATE	DWN	APVD
-		SEE SHEET 1	-	-	-

NOTES:

- MATERIALS AND FINISH
HOUSING: PA 6-6, UL 94-V0.
COLOURS: GRAY, RAL 7032.
 BLACK.
 GREEN.
CLAMP: BRASS, NICKEL PLATED.
DOUBLE SIDE CONTACT SPRING: PHOSPHOR BRONZE, TIN PLATED.
CLAMPING SCREW: M3, BRASS, NICKEL PLATED.
- MECHANICAL
MAX. INSERTION FORCE PER POLE : 3.0 N
MIN. WITHDRAWAL FORCE PER POLE : 1.5 N
WIRE STRIPPING LENGTH : 6.0-7.5 mm
RECOMMENDED TIGHTENING TORQUE FOR SCREW : 0.5 Nm.
- ELECTRICAL
WIRE RANGE : 12-30 AWG
MAX. VOLTAGE : 300 V
MAX CURRENT : 15 A
CONTACT RESISTANCE : <15 m Ohm
INSULATION RESISTANCE : >1000 M Ohm (500V DC)
- RECOGNIZED UNDER THE COMPONENT PROGRAM OF UNDERWRITERS LABORATORIES INC. FILE NO E60677.
- NOT CUMULATIVE TOLERANCE.
- INK MARKING : BLACK COLOUR
NUMERICAL SEQUENCE : FROM LEFT TO RIGHT,
WIRE ENTRY SIDE
- OPERATING TEMPERATURE RANGE: -40°C TO +105°C.

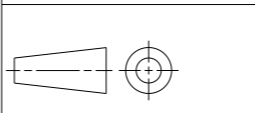
THIS DRAWING IS A CONTROLLED DOCUMENT.		DWN S. SCHLEGEL 25JUN96	STE TE Connectivity	
DIMENSIONS: mm		CHK R CANTORE 25JUN96		
TOLERANCES UNLESS OTHERWISE SPECIFIED:		APVD R CANTORE 25JUN96	NAME TERMINAL BLOCK PLUG, 7.5mm PITCH	
		PRODUCT SPEC -	- -	
MATERIAL -		APPLICATION SPEC -	SIZE A3	CAGE CODE 00779
FINISH -		WEIGHT -	DRAWING NO C-282959	RESTRICTED TO -
CUSTOMER DRAWING			SCALE 2:1	SHEET 2 OF 2
			REV C5	