

Modular Jack Connector for High-Speed Transmission

TM24R Series

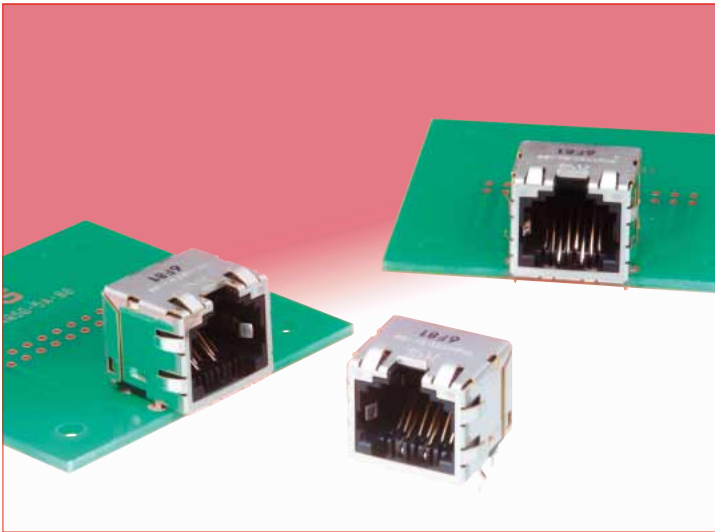

■ Features

1. Unique contact configuration and board-mounting pattern

The adjacent contacts have different angles of engagement thus increasing the distance between them, in effect reducing the cross talk within connector and its footprint. Contact #3 and #6, affecting the cross talk the most; have been isolated from other contacts resulting in maximum NEXT noise suppression.

In addition, the board layout allows easy tracing of the differential signal lines.

2. Full EMI shielding

The entire connector is covered with a metal shell. Multiple panel ground contact springs (2 on each side of the mating opening) and 4 board ground connection solder contacts placed at each corner of the connector guarantee effective suppression of noise radiation.

3. Sequential mating

Separate ground springs make contact with the mating connector's ground before the signal contacts, allowing equalization of any ground differential.

4. Conforms to FCC (Federal Communications Commission) standards

Meets requirements of FCC Title 47, Part 68, Subpart F.

5. RoHS Compliant

Considering environment compatibility, substances prohibited by RoHS are not used.

■ Applications

LAN related equipment, measuring instruments, office equipment and other high transmission speed applications requiring use of high performance modular jacks.

Unique Contact Configuration

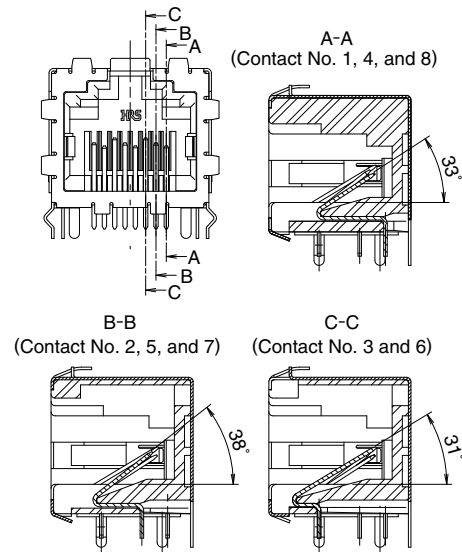

Recommended board layout for differential routing

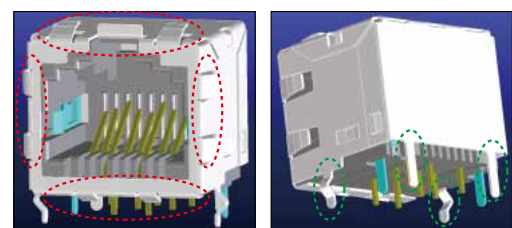
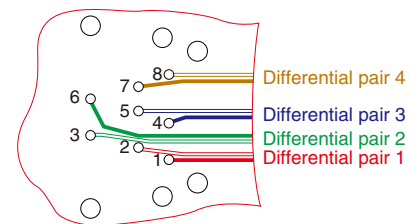

Panel ground contact springs

Board ground connection solder contacts

Separate ground springs

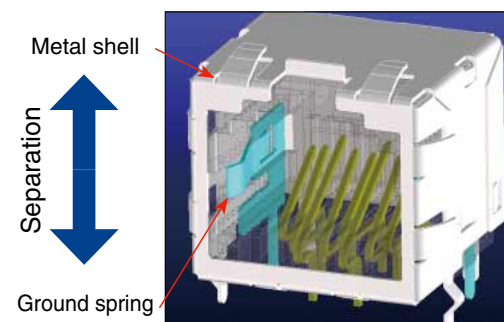

Product Specifications

Ratings	Current rating 1A	Operating temperature range : -55 to +85°C (Note)
	Voltage rating 125V AC	Storage temperature range : -25 to +60°C

Item	Specification	Conditions
1. Insulation resistance	100MΩ min.	100V DC
2. Withstanding voltage (Basic terminal between 123-456-78)	No flashover or insulation breakdown.	500V AC / 1 minute
3. Withstanding voltage (Terminal to shield)	No flashover or insulation breakdown.	1500V AC / 1 minute
4. Contact resistance	50mΩ max.	100mA
5. Vibration	No electrical discontinuity of 5μs or more. No damage, cracks, or parts dislocation.	Frequency : 10 to 55Hz, single amplitude of 0.75mm, 3 axis, 10 cycles
6. Shock	No electrical discontinuity of 5μs or more. Contact resistance : 60m ohms max.	Acceleration of 490 m/s ² , 11ms duration, sine half-wave waveform, 3 cycles / each of 6 axis
7. Durability (insertion/withdrawal)	Contact resistance : 60mΩ max.	700 cycles
8. Temperature cycle	Insulation resistance : 100MΩ min. Contact resistance : 60mΩ max.	(Temperature : -55°C → +15°C to +35°C → +85 → +15°C to +35°C Duration : 30 → 2 to 3 → 30 → 2 to 3 (Minutes) 5 cycles
9. Humidity	Insulation resistance : 1MΩ min. (High humidity) Insulation resistance : 10MΩ min. (Dry state)	500 hours at 40°C, HR 90% to 95%
10. Salt spray	Contact resistance : 60mΩ max.	5% water solution for 48 hours

Note : Includes temperature rise caused by current flow.
 Temperature range for mechanical operation : -25°C to +60°C

Materials / Finish

Part	Material	Finish	Remarks
Insulator	PBT	Color: Black	UL94V-0
Contact	Phosphor bronze	Contact area : Gold plated 1.27 μm Termination area : Gold plated 0.03 μm Under plate : Nickel plated 1 μm	-
Shield	Brass	Tin reflow plated 1 μm	-
Ground spring	Phosphor bronze	Tin reflow plated 1 μm	-

Product Number Structure

Refer to the chart below when determining the product specifications from the product number.
 Please select from the product numbers listed in this catalog when placing orders.

TM24 R SG - 5A 8 8

① ② ③ ④ ⑤ ⑥

① Series name	: TM24
② Connector type	: R...Jack
③ Shell type	: SG...Separate ground spring –outer shell
④ Jack type	: 5A...Right-angle dip
⑤ Jack opening code	: 8...8 contacts
⑥ Number of inserted contact	: 8...8 contacts

■ Modular Jack Connectors

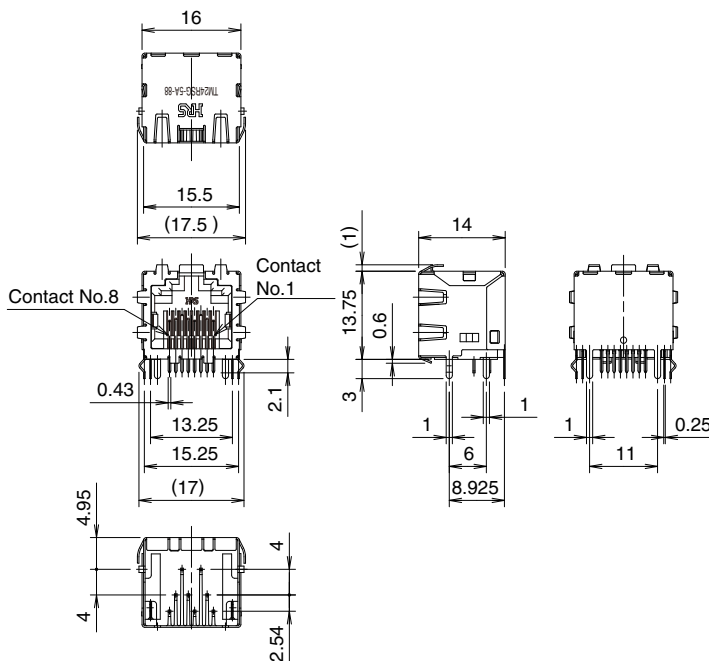

Part No.	HRS No.	RoHS
TM24RSG-5A-88	222-2946-7	YES

◆ Recommended PCB mounting pattern

◆ Recommended panel cutout

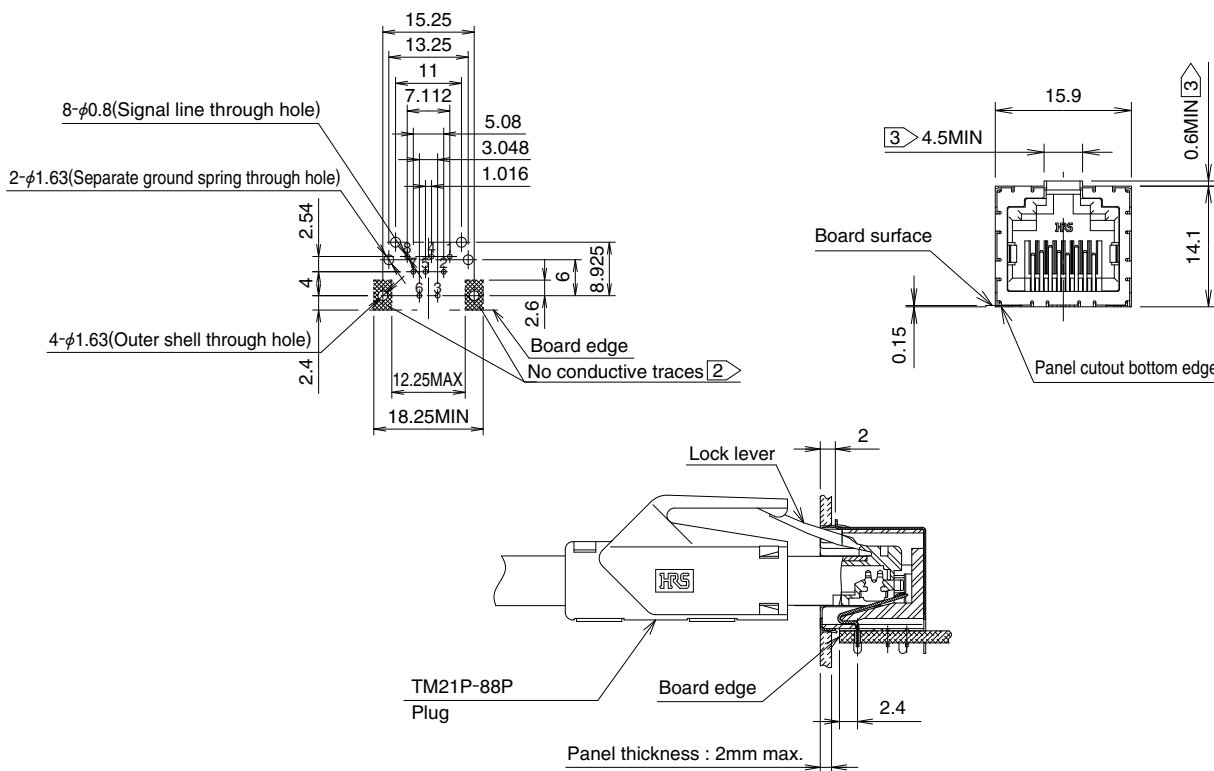

* Precautions and recommendations for board and panel design

- 1 . Recommended board thickness : 1.6mm.
- 2 . No conductive traces in the crosshatched areas.
- 3 . Make sure that the panel cutout has enough clearance to assure free operation of the lock lever of the mating plug.
- 4 . Make sure that the panel cutout bottom edge is 0.15mm below the board-mounting surface.
- 5 . Connector can be cleaned with isopropyl alcohol (IPA) at room temperature.

