

RUGGED HIGH-SPEED STRIPS

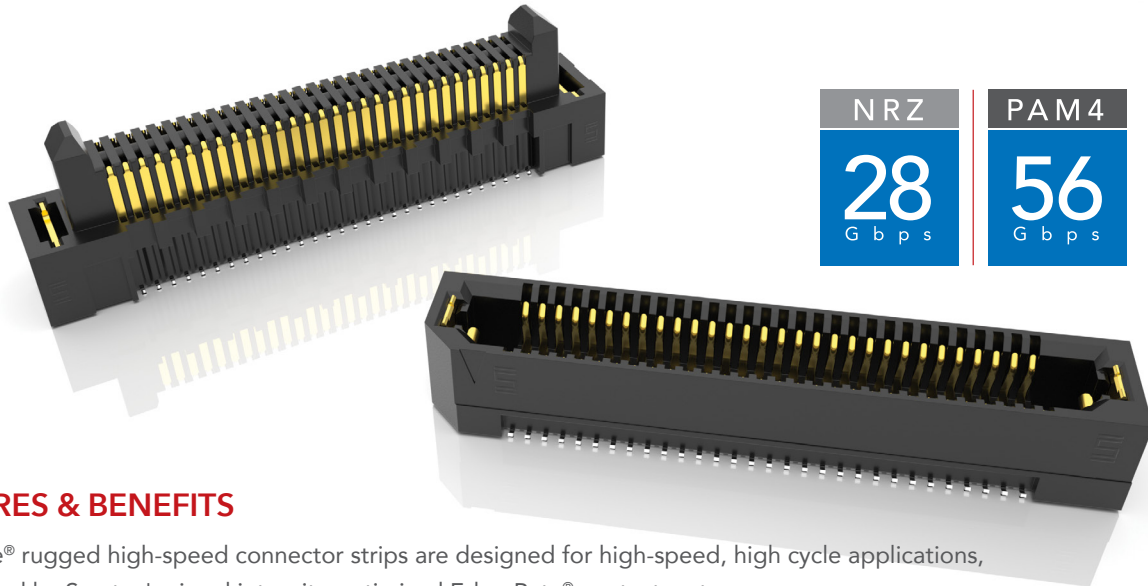

NRZ	PAM4
28 Gbps	56 Gbps

FEATURES & BENEFITS

Edge Rate® rugged high-speed connector strips are designed for high-speed, high cycle applications, and enabled by Samtec's signal integrity-optimized Edge Rate® contact system.

- Up to 1.5 mm contact wipe for a reliable connection
- 20 to 200 positions
- Choice of 0.50 mm, 0.635 mm or 0.80 mm pitch
- 0.50 mm pitch system offers up to 40% PCB space savings vs. 0.80 mm pitch
- 0.635 mm pitch system with extremely slim 2.5 mm body width
- Rugged latching, extended guide posts and 360° shielding
- Severe Environment Testing qualified (ERM8/ERF8).

Visit samtec.com/set

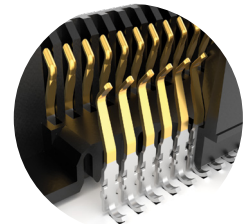

Signal integrity-optimized Edge Rate® contact system reduces broadside coupling

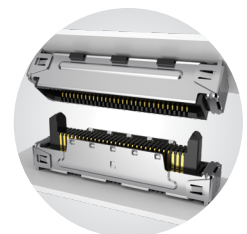

Rugged 360° shielding reduces EMI

EDGE RATE® STACK HEIGHT FLEXIBILITY

(shown in mm)

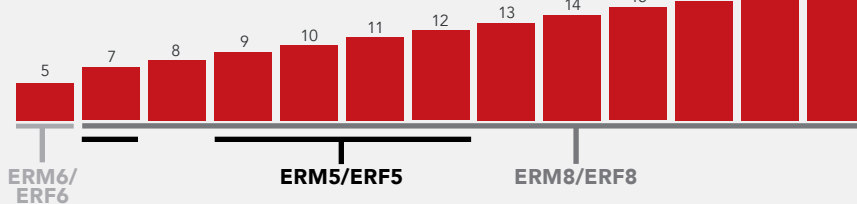

KEY SPECIFICATIONS

SERIES	PITCH	INSULATOR MATERIAL	TERMINAL MATERIAL	PLATING	OPERATING TEMP RANGE	CURRENT RATING	VOLTAGE RATING	LEAD-FREE SOLDERABLE
ERM5 / ERF5	0.50 mm	Black LCP	Phosphor Bronze or BeCu (ERM5), BeCu (ERF5)	Au or Sn over 50 μm* (1.27 μm) Ni	-55 °C to +125 °C	1.5 A	190 VAC/ 269 VDC	Yes
ERM6 / ERF6	0.635 mm		Copper Alloy			1.4 A	155 VAC/ 219 VDC	
ERM8 / ERF8	0.80 mm		Phosphor Bronze or BeCu (ERM8), BeCu (ERF8)			2.2 A	225 VAC/ 318 VDC	

(0.80 mm) .0315" PITCH • SHIELDED HIGH-SPEED HEADERS & SOCKETS

TYPE	POSITIONS PER ROW	LEAD STYLE	PLATING OPTION	DV	OPTIONS	"X"R
ERM8 = Shielded Terminal	-010, -020, -025, -030	-02.0 = 2 mm (ERM8 with -S only)	-L = 10 μ" (0.25 μm) Gold on contact, Matte Tin on tail		-S = Shield (Lead Styles: ERM8 -02.0, -03.0, -07.0, -09.0 only; ERF8 -05.0 only)	-TR = Tape & Reel
ERF8 = Shielded Socket		-03.0 = 3 mm (ERM8 with -S only)			-EGPS = Extended Guide Post Shield (Lead Styles: ERM8 -05.0 & -09.0 only; ERF8 -07.0 only)	-FR = Full Reel Tape & Reel (must order maximum quantity per reel; contact Samtec for quantity breaks)
		-05.0 = 5 mm			-DSS = Differential Pair with Extended Guide Post Shield (ERM8 only, with -05.0 & -09.0 Lead Styles, -10 & -025 Positions only)	
		-07.0 = 7 mm			-K = Polyimide Film Pick & Place Pad (-02.0 Lead Style N/A)	
		-09.0 = 9 mm			-P = Pick & Place Pad (ERM8 -02.0 & -05.0 Lead Styles only)	

ERM8-S
Board Mates:
See "Mated Height" Chart

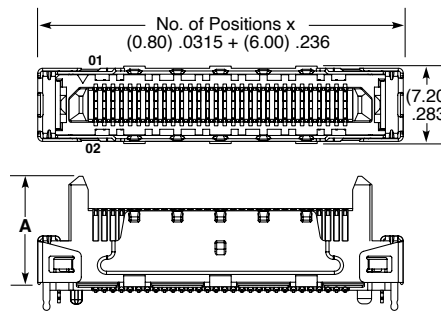
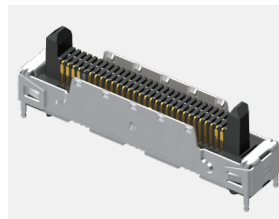

LEAD STYLE	A	B	C
-02.0	N/A	N/A	(5.97) .235
-03.0	N/A	N/A	(6.97) .274
-05.0	(9.87) .389	(10.81) .425	(8.91) .351
-09.0	(13.87) .546	(14.81) .583	(12.91) .508

-S OPTION **-EGPS OR -DSS OPTION**

View complete specifications at: samtec.com?ERM8

ERF8-S
Board Mates:
See "Mated Height" Chart

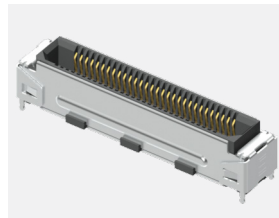

MATED HEIGHTS					
7 mm	8 mm	10 mm	12 mm	14 mm	16 mm
ERM8-02.0-S	ERM8-02.0-S	ERM8-02.0-S	ERM8-05.0-EGPS	ERM8-05.0-EGPS	ERM8-09.0-EGPS
ERF8-05.0-S	ERF8-05.0-S	ERF8-05.0-S	ERF8-07.0-EGPS	ERF8-05.0-S	ERF8-07.0-EGPS

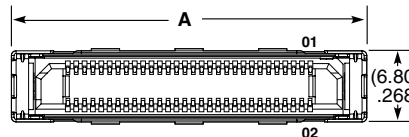

LEAD STYLE	B (-S)	B (-EGPS)
-05.0	(5.90) .232	N/A
-07.0	N/A	(7.42) .292

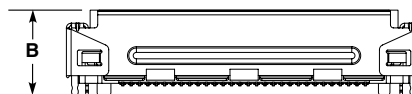

-S OPTION

POSITIONS PER ROW	A
-010	(18.00) .71
-020	(26.00) 1.02
-025	(30.00) 1.18
-030	(34.00) 1.34

Notes:
Severe Environment Testing qualified.
Visit samtec.com/set

Some lengths, styles and options are non-standard, non-returnable.

View complete specifications at: samtec.com?ERF8